



Tube - Line 5500

Owner's Manual

2001

Manufactured By:

TubeLine Manufacturing Inc.

RR#3 Listowel,
Ontario, Canada
N4W 3G8

Tel: (519)291-4162

Fax: (519)291-5388

Tube - Line 5500

Operation





Warranty and Limitation Of Liability

All Equipment is sold subject to mutual agreement that it is Warranted by the company to be free from defects of material and workmanship. But the company shall not be liable for special, indirect or consequential, damages of any kind under this contract or otherwise. The company's liability shall be limited exclusively to replacing or repairing without charge, at it's factory or elsewhere, at it's discretion. Any material, or workmanship defects which become apparent within one year from the date on which the equipment was purchased, and the company shall have no liability for damages of any kind. The buyer by the acceptance of the equipment will assume all liability for any damages which may result from the use or misuse by his employees or others.

Warranty coverage is null and void unless Warranty Registration form has been completely filled in and is on file at Tube-Line Manufacturing Inc.



Troubleshooting Tubeline 5500 Balewrapper

Symptom	Problem	Solution
Ram cylinder extends on auto, retracts about 3" extends, and starts to reciprocate	Table Trigger Switch stays on	Check for broken or unhooked return spring, make sure hinge is free
With Man/Auto switch on man turning Forward switch, ram starts to move and wrap starts at the same time	Battery cables reversed	Reverse Battery cables Pos. live Neg. ground
On "man" with "for" switch turned, ram cylinder extends but "rotate" switch will not start wrap motor	No hydraulic fluid going to wrap motor	Shift flowcontrol lever closer to the middle
On "man" Rotate works but "for" does not work	No hydraulic fluid going to ram cylinder	Shift flowcontrol lever closer to the middle

Turn on/off switch off before boosting or charging battery

Set Up For Tube Line

Spacing
Width Of
Bale Apart

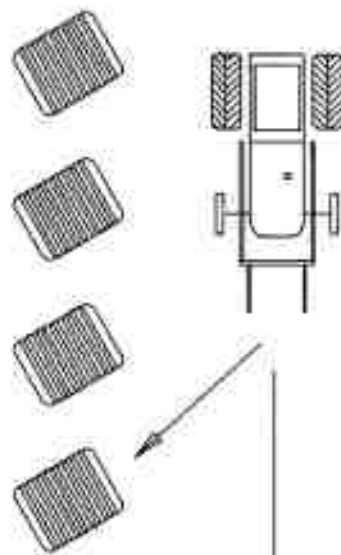

Note
Initially Takes
4 to 6 Bales
Before
Tube Line Moves

Direction
Of Travel

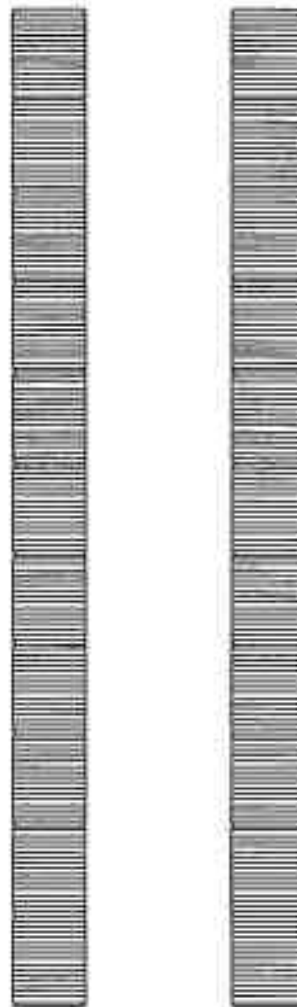
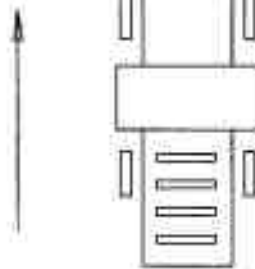

If bales are brought
to the site before
wrapping, arrange
them to allow easy
access to bales and
allow tubeline plenty
of room to move

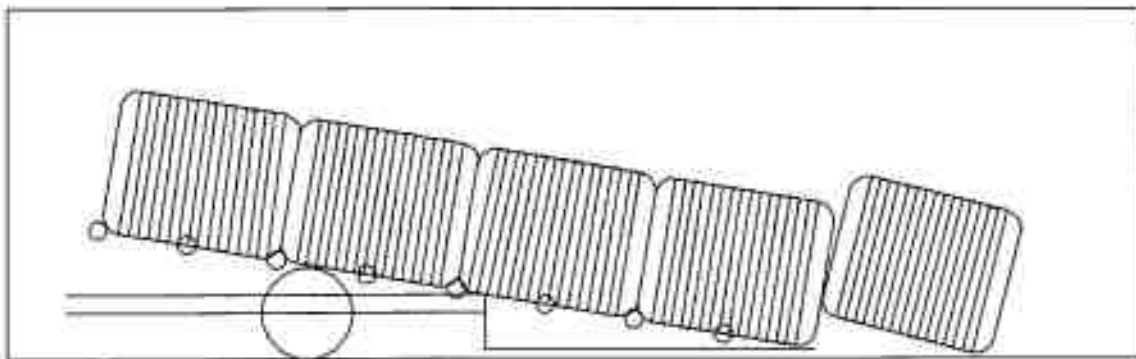

The first bale tips as
the line forms and
may be picked up
when the row is well
started



SILAGE

HAY/STRAW

A bale of hay or straw
is added to protect
the end of the line

Operating the Model TL5500 Tube-Line Bale Wrapper

Big Bale Silage

The objective of big bale silage is to provide high quality forage using a minimum of equipment. To do this, crop must be cut at the correct stage of maturity, wilted, baled tightly and wrapped air tight using a good quality stretch wrap.

The Tube-Line wrapper makes timely harvest possible by reducing the dependence on the weather. It is much easier to get weather to wilt silage than to make dry hay. This also extends the working day, as forage is at the correct moisture to bale earlier and later in the day.

Bales

Well-shaped firm bales are necessary for successful wrapping. Bales are best wrapped as soon as possible after baling. If bales are left unwrapped, they will sag and lose shape. Heating will start soon after baling and protein quality will be lost. It is desirable to wrap within four hours. In an emergency such as rain, bales can be left 12 to 16 hours.

Moisture

Successful silage can be made over a wide moisture range. In general, 40 to 50% moisture is satisfactory for dairy cows. Some beef farmers prefer 60 to 70% moisture as it limits intake. A good rule of thumb is to dry "Half-way to hay". Drier silage gives you:

1. lighter bales to handle
2. more desirable fermentation with less odour
3. less freezing in the winter
4. higher dry matter intake

Wrapping Site

Select a site which will allow room to make an adequate bale row length. The Tube-Line is a very fast wrapper, but requires time to set up and move to a new line. There should be space for at least 50 or more bales in a row.

Select a site that is accessible in winter conditions and does not flood in the spring.

A firm surface is necessary for the successful operation of the Tube-Line. Avoid soft ground, as the wrapper will not move forward smoothly if it is sinking into the ground. Wrap on the level or up a slight grade.

A site that is free from grass and debris will be less likely to attract rodents that can damage the plastic.

Bale Size

ROUND BALES The Model TL5500 will wrap bales of up to 5½' wide and up to 5' high. It will wrap all sizes smaller than these dimensions as well.

Remember when making big bale silage, the bales will be heavier than dry hay. This puts extra strain on loading and transporting equipment. Also, bales will be heavier when feeding out and may have to be moved on wet ground or snow. As a result, most operators reduce silage bale diameters to 4-4½', even though the wrapper and baler will handle larger bales.

Square Bales

The Model TL5500 will wrap most sizes of square bales. The length should be reduced to 5'. This is to allow the bales to be placed on the bale receiver. This may also be the maximum length advisable to handle big square bales of silage.

Bales which are approximately 4' wide and 2' high can be stacked two high for wrapping.

Bales which are approximately 3' wide and 3' high do not stack well. These may be wrapped in a single tier of bales.

Big square bales must be wrapped manually, or with the remote control kit. When stacking two high, the first bale would activate the automatic device prior to loading the second bale.

Extra care must be taken to ensure that extra film is applied at the bale joints if the bales are uneven.

Recommended Operating Procedure

We suggest the following method of operating the TL5500 Tube-Line Wrapper.

- Park the wrapper where you want the end of the row to be, facing in the appropriate direction.
- Fold front section of tongue and insert bracket in hydraulic steering pin.
- Start the engine
- Undo tail tiebar hairpin and lay bar over rear axle and put hairpin back into place to prevent loss.
- Lower the tail section using the operating valve.

Caution: To Prevent Injury—Prior to lowering wrapper tail section, be sure to check that all bystanders are standing clear.

- Lower the tail section using the manual operating valve

Installation Of Plastic

The roll of plastic should be installed so that the inside of the plastic film should go next to the bale of silage. The plastic then passes over the slave roller and is threaded through the two metal rollers on the tensioner as shown in the diagram.

The two metal stretcher rollers rotate at different speeds. This causes the plastic to be stretched. It is very important that the plastic goes over the slow roller first and the faster roller second.

If there is any question on which is the faster roller:

1. Place a pen mark on each roller and rotate one roller one turn.
2. Check the location of the mark on the other roller.

If it has advanced further, then it is the fast roller.

If it has advanced less, then it is the slow roller.

When the plastic is installed correctly, it should stretch tight on the bale to form a smooth tube.

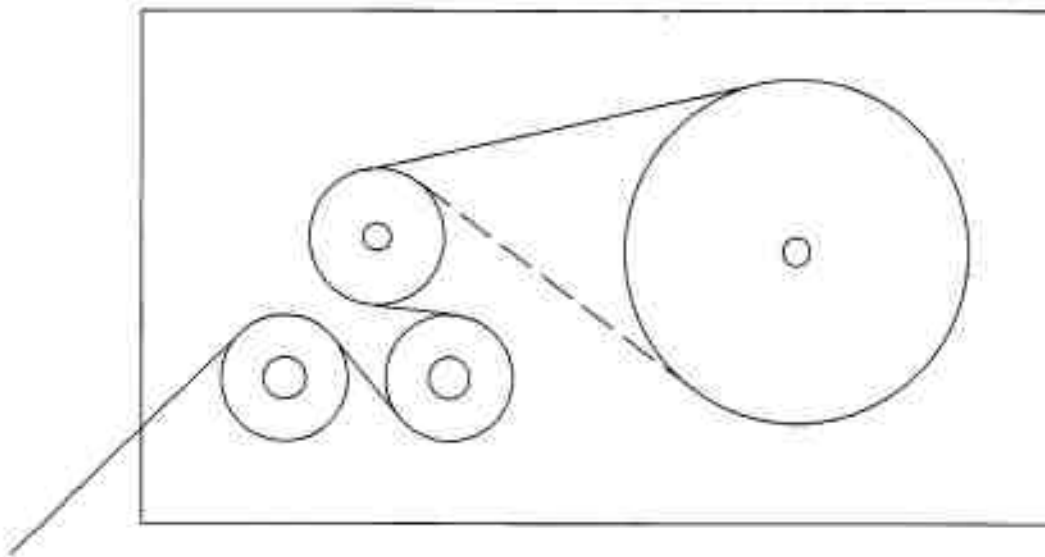

Trouble Shooting Plastic Installation

1. Wrinkles in the plastic with seams between layers easily visible.
Check to determine if plastic is properly routed through the metal tensioner rollers.
2. Plastic tears between tensioner and bale.

Reel holders not turning freely. Lubricate and turn manually until free.

Slave roller not turning freely. Lubricate and turn manually until free.

Poor quality plastic. Use a brand with a good tare resistance. Tack build-up on rollers. Particularly in hot weather, the tack, which sticks the layers of plastic together, can build up on the rollers. Clean the tensioner with warm soapy water.

Plastic roll is too hot. In very hot weather the plastic can become soft if left in the sun for long periods of time. In these conditions, the spare rolls should be kept in the shade. The roll after installation on the machine can be parked under the roll of wrapped bale if not used for an extended period of time. In extreme heat, the top position roll on twin tensioner machines can be covered to provide shade when not in use.

Roll of plastic catching on the bottom of the bale. If bales are misshapen, the roll of plastic may drag on the bottom of the bale, causing the plastic to break.

If wrapper is equipped with electric automation:

Switch the control to manual.

Caution: Prior to rotating hoop, check to be sure guards are in place and all persons are clear of hoop.

-Test the hydraulics by rotating the hoop and moving the bale ram back and forth.

-Install the roll of plastic according to Plastic Installation diagram.

Dotted line is an alternative method of installing plastic.

Caution: Close guards after installing plastic to avoid injury.

Caution: Round bales are heavy and silage bales are even heavier. Use only authorized bale-handling equipment. Keep bales low when turning loader.

Bale Guide Bars

The bale guide bars are designed to align the bales as the bales are set on the wrapper. These bars should be adjusted to set firmly against the bale when the bale is placed on the wrapper. If bars are too far apart, the bales will not align and the plastic joints will not be tight.

If the guide bars are too close, the bales will not set down until they have entered the wrapping hoop. This will cause the row of bales to have a 'saw-toothed' appearance. Again, the seal between the bales will not be as tight.

Adjust the guide bars when a change is made in bale size.

To Wrap Bales with **Model TL5500A** (automatic)

Open the bale pusher and place the first bale on the table. Push this bale and two other bales through the hoop. This gives a stable end for the line. These bales can be picked up and placed on the wrapper later when the line is formed and wrapped later. Alternatively a bale of straw can be used to form a tight seal in addition to the plastic sheet or bag.

-Pull about 4' of plastic through each plastic stretcher and tie it under the twine on the third bale. Or tie it to the bracket at control panel (see picture on page 14).

-Place a single bale bag or a sheet of plastic on the next bale to form the end seal.

-With control panel switch "auto/man" set to "man" turn "forward" button in to advance bale without the plastic stretcher applying plastic.

-As the bale is pushed through the hoop, start the plastic dispenser rotating to apply plastic by pushing in the "Rotate" button.

-When the ram hits the switch at the end of stroke forward motion on cylinder will stop, "this switch can be moved on the slider arm to accommodate your needs. More about this later."

-With switch set to "man", the switch buttons have to be turned and/or pushed and held, when you let them go the function will stop.

-Turning, reverse button will retract the ram and open the bale pusher to accommodate the next bale.

-After you have wrapped a few bales in this way, switch "auto/man" switch to "auto" and place bale onto bale table, as bale depresses the table trigger the cycle will start automatically, adjust front slider switch to start the wrap cycle.

-To stop cycle after the cycle has started in the automatic mode turn on/off switch to "off". (or if you have the optional remote kit, push engine stop switch to stop the engine.) Before starting engine again, turn "on/off" switch to "off" then back to on, or turn "man/auto" to "man" to reset the control relays. After you have rectified the problem finish the rest of cycle in the "man" mode and then return to "auto" mode.

Steering

The wrapper is equipped with hydraulic steering. The purpose of this is to keep the wrapper operating in a straight line or direct the wrapper around obstacles. If the ground is uneven or the wrapper is operated on a side hill then it can drift out of line. The loader operator is usually able to detect if the wrapper is not moving in the desired direction. Also the steering can be used to go around obstacles in the wrapping path. Do not make sharp turns as this prevents the bales from being tightly packed together. With the automatic wrapper the steering speed can be adjusted with the needle valve at the manifold block.

-When starting the row, align the wrapper in the desired direction for the row and ensure the steering is in the center position.

With - Optional Remote Control-

With optional remote control the machine can be controlled with the hand held unit. The table trigger switch should be unplugged. Then the control panel, "man/auto" switch on "auto", bale can be placed on table without cycle starting. After the bale has been placed, and you want the cycle to start, press the start button on the hand unit. The machine will now go through the complete wrap cycle and stop at the end of the cycle. Two of the remote buttons are used to control right and left steering. The forth button is the remote engine stop, this button will have to be held in until the engine has come to a complete stop.

-Notice-

When the engine is not running; and the control panel "on/off" switch is turned "on", "auto/man" is on "auto", the table trigger is depressed, then the ram extend valve will be energized, draining the battery until "auto/man" switch is turned to "man", or "on/off" switch is turned to "off". The LED will also be off if the switch is turned "off". The engine does not have a battery ignition; therefore it will not drain the battery when the ignition switch at the engine is left on and the engine is not running.

-Slider Switches-

Adjust the front slider switch to start the rotate motor when the bales have made contact. By adjusting the slider switch at the rear of the slider bar, which will stop the ram and wrap motor, and reverse the ram cylinders. Adjust it so that the junction of the 2 bales are in the wrap chamber. It is possible to adjust the front slider switch so the wrap will start just before the bales start moving through the wrap chamber, thereby putting extra plastic on the joint of bale.

To Wrap Bales with **Model TL5500** (with the manual hydraulics)

Open the bale pusher and place the first bale on the table. Push this bale and two other bales through the hoop. This gives a stable end for the line. These bales can be picked up and placed on the wrapper later when the line is formed and wrapped later. Alternatively a bale of straw can be used to form a tight seal in addition to the plastic sheet or bag.

-Pull about 4' of plastic through each plastic stretcher and tie it under the twine on the third bale. Or tie it to the plastic loop bracket at the control panel, see picture on page 14.

-Place a single bale bag or a sheet of plastic on the next bale to form the end seal.

-Set the selector valve to 'bale only'. This will allow the bale to move without the plastic stretcher applying plastic.

-Place this bale on the table. Push it to the hoop.

-As the bale is pushed through the hoop, start the plastic dispenser rotating to apply plastic by operating the 'wrap' valve.

-The bale should be advanced 4" for each rotation of the plastic dispenser. This will apply 4 to 5 layers of plastic.

-Until the operator is familiar with the operation of the wrapper, it is best to advance the bale about 4", do a wrap of plastic, advance the bale, do a wrap, etc. When the operator is familiar with the machine, set the flow valve so that the correct amount of plastic is applied as the bale is moved forward.

-Set the selector valve to 'both'. This will start the plastic when the bale is being pushed.

If there is a space between the bale after it is loaded and the previous bale,

Set selector valve to 'Cylinder Only'

Advance the bale until it contacts the previous bale

Then move the selector valve to 'Both'

If the bales do not line up then put on extra wrap at junction of the bales to ensure a good seal.

-Careful application of an adequate amount of plastic is critical to give a good quality product. Careless application of plastic will result in losses. Continually watch the row for dark "window" indicating that not enough plastic has been applied.

Steering

The wrapper is equipped with hydraulic steering. The purpose of this is to keep the wrapper operating in a straight line or direct the wrapper around obstacles. If the ground is uneven or the wrapper is operated on a side hill then it can drift out of line. The loader operator is usually able to detect if the wrapper is not moving in the desired direction. Also the steering can be used to go around obstacles in the wrapping path. Do not make sharp turns as this prevents the bales from being tightly packed together.

-When starting the row, align the wrapper in the desired direction for the row and ensure the steering is in the center position.

Use Of The Operating Brake

The Model TL5500 is equipped with an operating brake. It is essential that bales be packed tightly together to ensure that the silage is sealed and will keep well. If the bales are not securely packed end to end, air can enter between the bales and cause spoilage.

It is best to choose a wrapping site where the wrapper operates on the flat or slightly up hill. If the ground is very hard and causes very little rolling resistance, or the wrapper must be operated down hill, then the brake must be used to pack bales.

The brake is operated by using the brake hydraulic valve. Moving hydraulic lever will cause oil pressure to apply brakes on the rear wheel. Increase pressure to the point where the bales are packed firmly together.

RELEASE BRAKES WHEN THE ROW IS FINISHED AND PRIOR TO TRANSPORTING THE WRAPPER.

Completing The Row

-When the desired row length has been reached, place a bale bag on the bale to seal the end.

-Continue to apply stretch wrap until the bag is completely wrapped.

Pushing off the bales from wrapper

-The automatic wrapper will have to be switched to manual position for pushing bale off.

Caution: The use of automatic setting when pushing off bales will increase the risk of injury.

-To push off the bales

Open the bale pusher

-Remove the lynch pins from the front of push plate arms, unfold the arms to extend the push plate.

-Remove the lynch pins from the top of arms and swing the X bars onto the pins, replace the lynch pins to secure the X bar.

#1 Push bale through wrapper by using the forward button and wrap button with automatic machine or with manual machine with lever in "both" mode until you have enough plastic on bale.

Continue pushing bale through wrap chamber until you have reached the end of stroke.

#2 Retract the bale pusher.

#3 Refold the push plate arms and secure with lynch pins at front of arms.

#4 Pull the pins out at the back end of ram guides and insert them through the holes in bracket at rod end of ram cylinders.

#5 Open the safety doors, Remove 2 x 3 tube from engine side of wrapper and lay across the top of pushoff channel.

#6 Close pusher a second time to push bales off the wrapper.

#7 Open the pusher and move 2 x 3 tube to the next set of hooks and repeat until the bales are pushed off.

#8 Open the bale pusher, store 2 x 3 tube in bracket with lock pin.

#9 Remove push channel pins at rod end of ram cylinders and reinsert them at the back end of ram guides.

#10 Fold up tail end of roller table using the "tail" valve and secure with tie bar.

#11 Undo steering, unfold tongue and insert lockpin.

#12 Check to make sure the brakes are turned off before driving away.

CAUTION: DO NOT TOW BALE WRAPPER AT SPEEDS OVER 35KPH.

Daily Maintenance:

Lubricate all grease points

Apply liberal amounts of grease to the pusher slides daily or when the slides appear dry.

NOTE: PLASTIC STRETCHER IS TO BE GREASED ONLY ONCE PER SEASON!

When wrapping in hot weather there can be a build-up of adhesive on the plastic stretcher. This can cause the plastic to break. If there is a build-up of adhesive. Wash stretcher with soap and water.

Wrapping Dry Hay & Straw

The TL5500 wrapper can be used to weather protect dry hay and straw. HAY SHOULD NOT BE WRAPPED TIGHTLY AS IT STILL CONTAINS SOME MOISTURE.

Only two layers of plastic are necessary. For hay leave space in the plastic at the joints of bales. This is done by stopping the plastic dispenser and pushing the bale through to leave a space. This will allow the moisture to bleed out and still protect the bale from rain and ground moisture.

If straw is dry, it may be wrapped continuously without spaces. Straw that has some moisture is best wrapped with spaces in the plastic.

After wrapping:

After wrapping inspect rows of silage regularly to ensure there is no damage occurring from birds, rodents or livestock.

Feeding Out:

With the TL5500, bales can be picked by a loader without cutting the plastic. The plastic breaks away between bales and can be removed from the side of the bales before dropping the bales in the feeder.

Tube-Line wrapped bales do not spoil as the line is fed. Unlike long bags of bales, the stretch wrap prevents air from moving past the bales and causing the bales at the far end to heat. As the next bale is undisturbed it will not spoil for one to two days in warm weather and for at least a week in cooler weather.

Disposal Of Plastic

Users of bale wrappers are encouraged to collect all plastic to prevent it from becoming an environmental problem. If there is a high temperature incinerator in your area, the plastic can be safely burned without producing hazardous by-products.

Plastic, although bulky, is inert in a landfill and will not pollute ground water.

Manufacturers are making serious efforts to economically recycle silage plastic. Use a recycling service when available, collect and dispose all plastic. Unsightly used silage film will encourage complaints.

The design of Tube-Line Bale Wrappers is protected under Canadian Patent 1285862 and USA Patent 4793124.

Edited 11/2/00

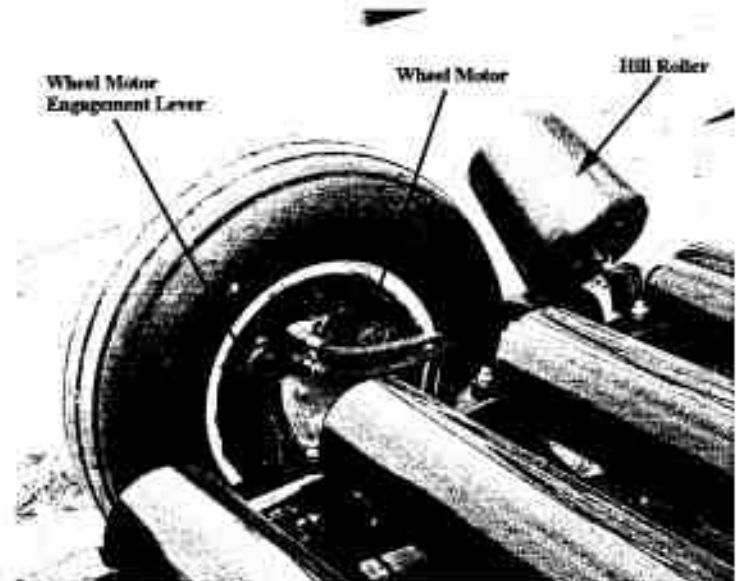
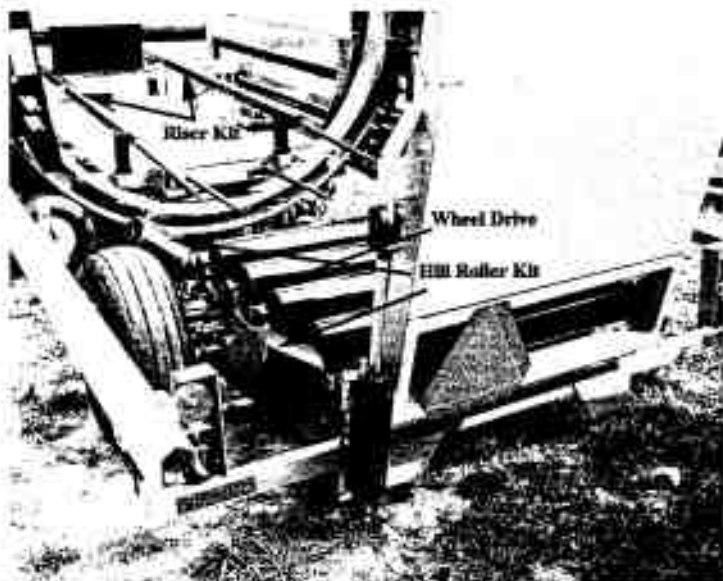
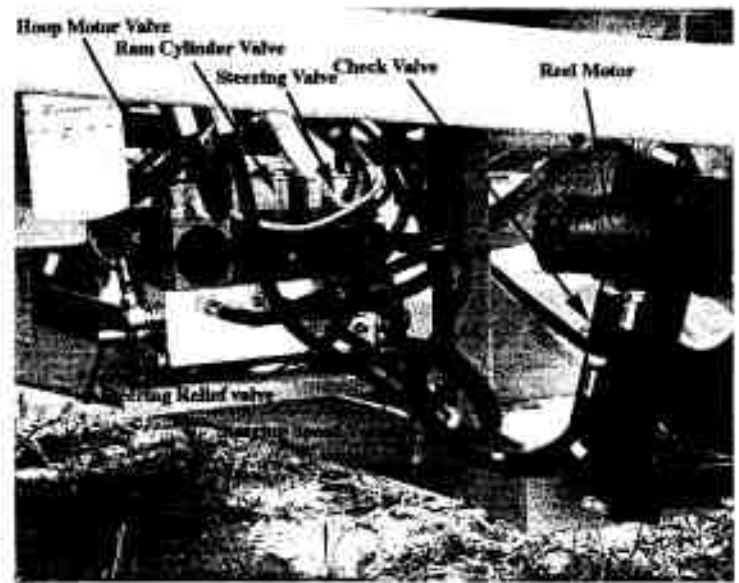
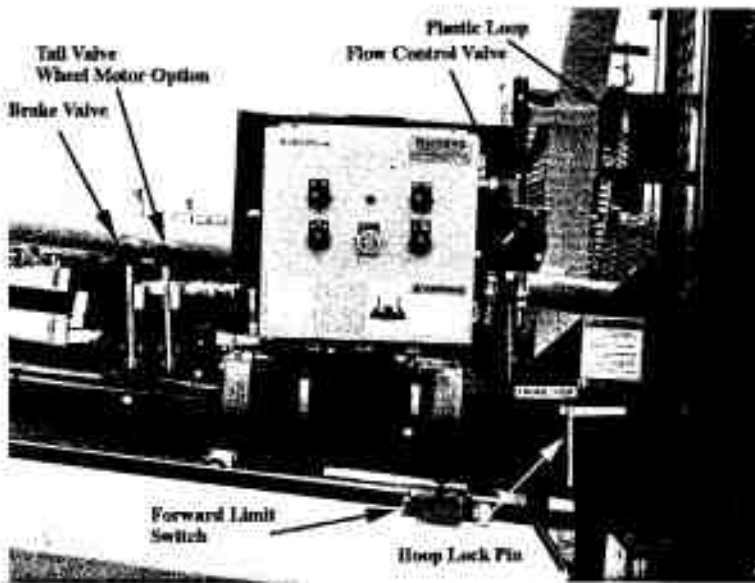
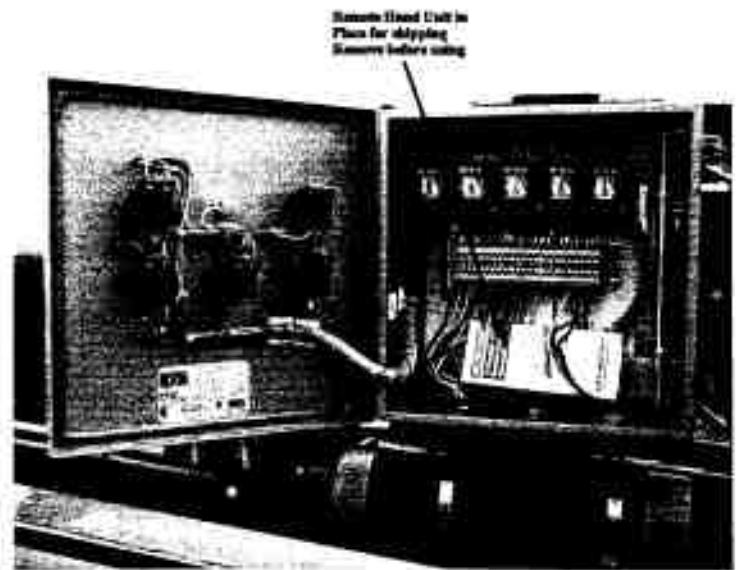
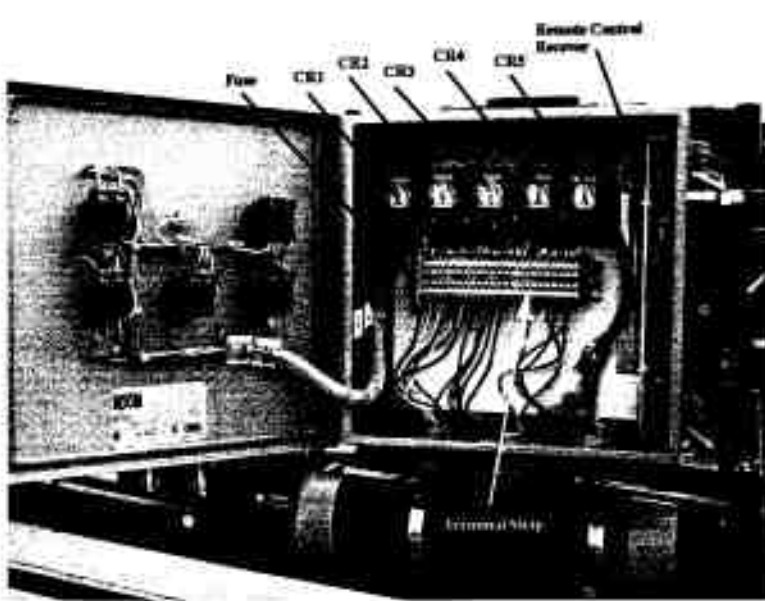

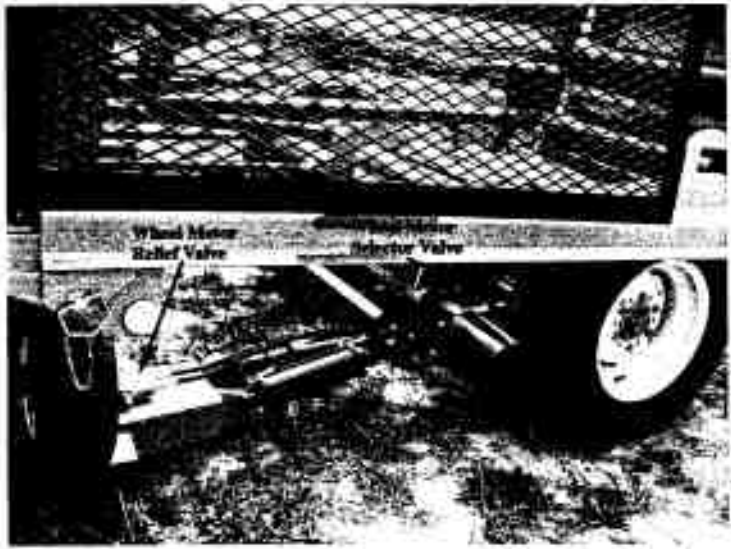
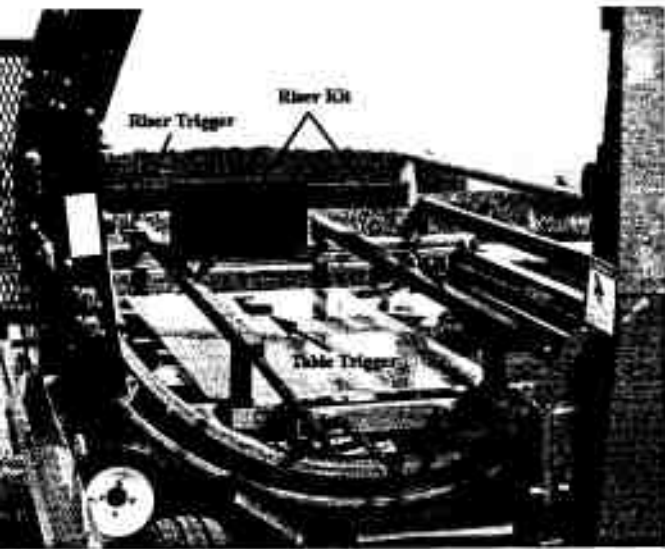

TUBE-LINE 5500

Hydraulic Pump

Prince Model # SP20A11A9HR
.677 cu in/rev
side ports inlet port 1 1/16-12 O-ring
outlet port 7/8-14 O-ring
mounting 2 bolt 'A' flange
shaft 5/8 keyed
rotation clockwise

Manual Valve

Prince Model SV
1 section SVWBB1
4way double acting w/3 position detent
Ports blocked in neutral
3 section SVWBA1
4way double acting w/spring centre
Ports blocked in neutral
Ports in and out 7/8-14 O-ring
Ports work 3/4-16 O-Ring

Electric Hydraulic Valve

Continental tandem centre 12 volt DC VS12MBLGB75
Continental single centre 12 volt DC VS12M1AGB75L
Prince 2 spool monoblock RD522CCAA5A4B1
Prince Power Beyond Plug #8 SAE 66028001

Hydraulic Motor

EATON Char-Lynn 101-1004
1" keyed straight shaft
1/2 pipe ports
9.7 cu in/rev displacement
4 bolt flange

Hydraulic Oil

SAE # 10 Hydraulic Oil
10 US gal

Hydraulic Filter 10 micron

Stauff - SF6520
Gresen - F22001
Fram - P1653-A
Fleetguard - HF6510
Cross - 1A9021